



Self-Study Training Program

Servicing Spring Brakes

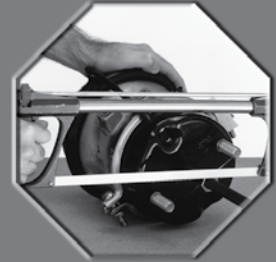

Table of Contents

- Introduction/How To Use The Study Guide 2-3
- MGM Brakes: Brief Company History 4
- SECTION 1: Foundation System..... 5-6
- SECTION 2: Spring Brakes and Service Chambers..... 7-9
- SECTION 3: Maintenance 10-16
- SECTION 4: Manually Releasing the Brake 17-19
- SECTION 5: Replacing the Single/Piggyback Chamber 20-23
- SECTION 6: Removal and Replacement of the Service Diaphragm..... 24-25
- SECTION 7: Removing the Combination/Tandem Brake..... 26-27
- SECTION 8: Procedure to Cut the Universal Service Push-Rod 28-29
- SECTION 9: Reinstalling the Combination/Tandem Brake..... 30-33
- SECTION 10: Recommended Disposal Procedure 34-35
- SECTION 11: Brake Adjustment 36-39
- SECTION 12: 3-Inch “Long Stroke” Brakes..... 40-42
- NOTES..... 43
- FINAL REVIEW 44
- QUIZ QUESTIONS 45-59
- NOTES..... 60-62
- MAIL-IN QUIZ..... 63

NOTE: Although every precaution has been taken in the preparation of this booklet, MGM Brakes assumes no responsibility for errors or omissions. Neither is any liability assumed for damages resulting from or claimed to be the result of the use of the information contained herein. Information subject to change without notice. MGM Brakes and IHI shall have no liability of any kind for damages arising out of any other use of the information contained within this booklet.

Copyright ©2000 MGM Brakes

All rights reserved.

Printed in U.S.A.

Revised 1/2011

No part of this booklet shall be reproduced, stored in a retrieval system, or transmitted by any means, electronic, mechanical, photocopying, recording, or otherwise, without written permission from MGM Brakes.





Self-Study Training Program

Introduction

Welcome to MGM Brake's **BrakeTECH SERVICE Self-Study Training Program**. MGM Brakes created this program for maintenance personnel involved in maintaining and repairing the service and spring brake chambers on commercial vehicles and heavy equipment.

This booklet has been designed to allow you to work at your own pace, regardless of your schedule, to become better acquainted with the maintenance and safety procedures relating to the repair, replacement, inspection and preventive maintenance of service chambers and spring brakes in general, and MGM Brakes products in particular.

How To Use The Study Guide

Begin by carefully reading the text portion of each chapter. Feel free to make notes, underline, or highlight if you wish. This can help you remember what you have read.

At the end of this booklet you will find a final review quiz. This is your final test. Be sure to answer each question to the best of your ability. The questions contained in the quiz are straightforward multiple choice or true and false, and there are no "trick questions". If you are unsure about your answer to a particular question, review the appropriate chapter. The correct answer to the question is contained in the

text of the chapter. Study at your own pace. There is no time limit on completing this program. MGM Brakes will issue a “Certificate of Completion” and a patch to each participant scoring a minimum of 85%. Information on how to obtain your Certificate and patch is provided at the end of this booklet.

MGM Brakes:

Brief Company History

MGM Brakes was established in 1957 when John Miller, Sven Gummer, and Joseph Meyer developed and marketed the very first MGM Brake. Gummer, owner of a sawmill and a logger himself, had experienced first-hand the dangers inherent in hauling heavy loads up and down steep, rugged, poorly developed forestry “roads”. This environment was a torture chamber for the braking systems commonly found on heavy trucks during that time period. Frequent brake failures resulted in costly accidents and even loss of life.

Recognizing the need for a device that would lesson the probability of such events occurring, Gummer and his two colleagues succeeded in inventing an innovative safety device which they fitted to their trucks with excellent results. This MGM Brake soon swept through the logging industry and quickly revolutionized the entire trucking industry.

Vehicles fitted with spring brakes had a real safety advantage. Sudden losses in emergency brake system air pressure will cause the spring brake to engage, giving the operator the ability to bring a fully loaded vehicle to a safe, controlled stop. Manual release of the system air, utilizing a dash-mounted valve, also provided the operator with an effective parking brake.

The spring brake became very popular during the ensuing decades, and MGM Brakes grew to become the premier spring brake manufacturer/supplier in the world. Today, MGM Brakes, the acknowledged leader in the development of new spring brake technology, is the only “full-line” spring brake manufacturer in the world, offering more types, more models, and more combinations of brakes for the widest and deepest product line in the industry (**Fig. 1**).

MGM Brakes offers two types of double-diaphragm spring brakes, one with a detachable release tool and one with an integral release tool, as well as a full line of piston-diaphragm spring brakes. Many models are available in both standard and 3-Inch “Long Stroke” designs. “Severe Service” spring brakes, targeted at industries with characteristically harsh environments such as mining, livestock hauling, industrial waste and refuse, are also available. Additionally, MGM Brakes manufactures remote mount cylinders (typically used as tailgate locking mechanisms), as well as wedge brakes. Combining this robust line up with our

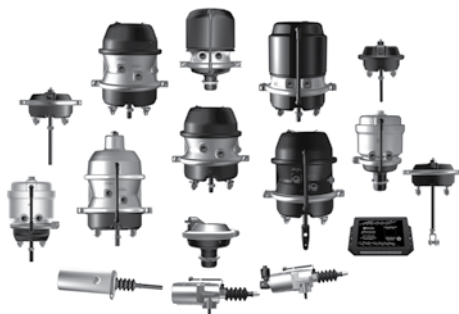

Figure 1

expansive array of service chambers, it soon becomes evident just why MGM Brakes is the industry leader, and why MGM Brakes products are standard equipment on more than 125 makes of heavy-duty vehicles in over 40 countries.

SECTION 1

Foundation System

The actual braking function is performed by the foundation brake which consists of the brake drum, spider, brake shoes and linings, camshafts, return springs, anchor pins and rollers. While the brake chamber converts air pressure into mechanical pressure, the foundation brake is where motion (kinetic) energy is converted into heat energy (friction).

There are three types of air operated foundation brakes used on medium and heavy-duty trucks:

- Cam Brakes
- Wedge Brakes
- Disc Brakes

Cam Brakes

Cam brakes represent the most commonly used foundation brake on heavy-duty commercial vehicles today (**Fig. 2**). Cam brakes operate through the action of the brake chamber, which is attached to a bracket mounted to the foundation brake. The brake chamber operates on compressed air supplied through the service port to the top of the service diaphragm. When compressed air enters the service chamber, the service diaphragm is forced downward against the service piston. The service piston is linked to the foundation brake by the piston push-rod, which is connected to a manual or automatic slack adjuster by a yoke. The slack adjuster is attached to the camshaft, and when the push-rod is forced outward, the slack adjuster transforms the movement, which is linear force, into a twisting, or rotating



Figure 2

force, or torque. The torque applied to the end of the camshaft causes the “S” cam on the other end to rotate, spreading the brake shoes. This forces the brake linings out against the drum, slowing the vehicle.

Wedge Brakes

While cam brakes rely on the slack adjuster to transfer linear force into torque to apply the brakes, wedge brakes operate entirely on a different principle (**Fig. 3**).

Wedge brakes utilize a “wedge and roller” assembly to spread the brake shoes and force the lining against the drum. The angle of the wedge and the size of the brake chamber determine the braking force that is generated. Thin wedges with small angles produce greater braking force over larger wedges with larger angles.

The operation of the wedge brake is rather simple. As air enters the service chamber, the push-rod—which is against one end of the wedge assembly—forces the wedge

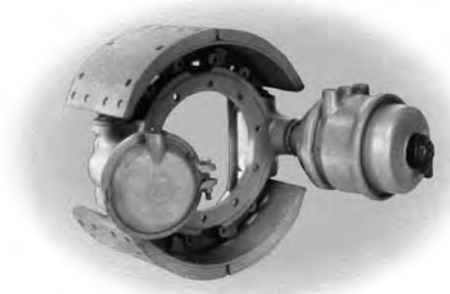

Figure 3

into the actuator between the adjusting and anchor pistons (or plungers, as they are sometimes called). This moves the pistons onto the wedge assembly rollers, forcing the brake shoes out, contacting the lining against the drum, thus slowing or stopping the vehicle.

Disc Brakes

Disc brakes (**Fig. 4**) consist of two parts:

- A rotor which is a round, cast iron disc that attaches to and rotates with the wheel hub.
- A caliper, which is an assembly that positions the brake pads relative to the rotor.

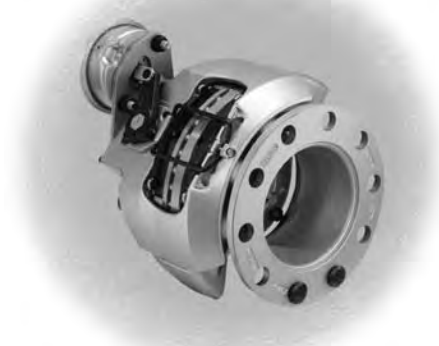

Figure 4

The brake “pads” (linings) fit into the caliper on either side of the rotor. As the brake is applied, the caliper squeezes the pads until they make contact with the rotor, causing it and the wheel to which it is attached to slow down and stop.

SECTION 2

Spring Brakes and Service Chambers

Service Brake

The service brake chamber (**Fig. 5, 6a**) functions independently of the spring brake chamber and provides stopping power for the vehicle during normal operation when full air pressure is available. When the brake pedal is depressed, compressed air fills the chamber. When this occurs, the influx of compressed air pushes against the diaphragm, simultaneously compressing the return spring and extending the push-rod. Since the push-rod is connected via a yoke and slack adjuster to the vehicle's foundation brake, whether drum or disc, the result is a gradual slowing of the vehicle dependent upon the amount of air pressure (force) that is applied to the diaphragm.



Figure 5

Spring Brake

Spring brakes function as:

- Service Brakes
- Parking Brakes
- Emergency Brakes

The spring brake has two chambers:

- A. The service brake chamber (**Fig. 6a**) performs the normal slowing and stopping function.
- B. The parking/emergency brake or “piggyback” chamber (**Fig. 6b**), mounted in tandem on top of the service brake chamber, contains a diaphragm (or piston) and a large powerful spring.

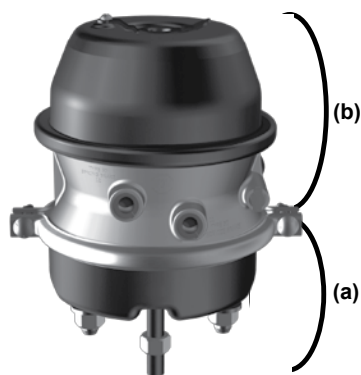

Figure 6



WARNING: Do not attempt to service or disassemble the spring chamber or any spring brake actuator. A large spring in the spring chamber, having extreme force, could cause serious bodily injury if it were suddenly released due to inadvertent removal of the clamp band or tamper-resistant head.

Currently, two main types of spring brakes are commonly used worldwide for applications on trucks, buses, trailers and other heavy-duty commercial vehicles: the double diaphragm type (**Fig. 7a**) and the piston-diaphragm type (**Fig. 7b**).

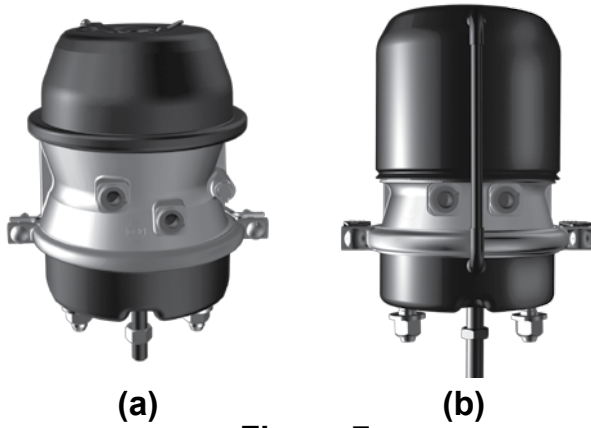

Figure 7

The parking brake (or emergency brake) chamber can utilize either a piston or a diaphragm and normally remains filled with compressed air when the vehicle is in operation. This air exerts pressure upon the diaphragm or piston (depending upon the design of the actuator), compressing the power spring, thereby holding the parking brake in the disengaged position (**Fig. 8a**).

Since the service brake and parking brake chambers are isolated from each other by a seal (**Fig. 8b**), the parking brake cannot interfere with the normal operation of the service brake.

The parking brake chamber serves two functions: 1.) it provides for parking the vehicle; 2.) it is part of the emergency brake system. To park the vehicle, air in this chamber is released by activating a parking brake valve generally mounted on the vehicle's dash. This releases the compressed air from the parking chamber, enabling the power spring to force the push-rod down toward the lower service chamber. This downward motion of the push-rod exerts force against the service chamber's push-rod, causing engagement of the vehicle's foundation brakes via the yoke and slack adjuster (**Fig. 8c**). The MGM manual release bolt allows easy release of spring brakes to reline brakes or move the vehicle in the absence of air pressure (**Fig. 8d**).

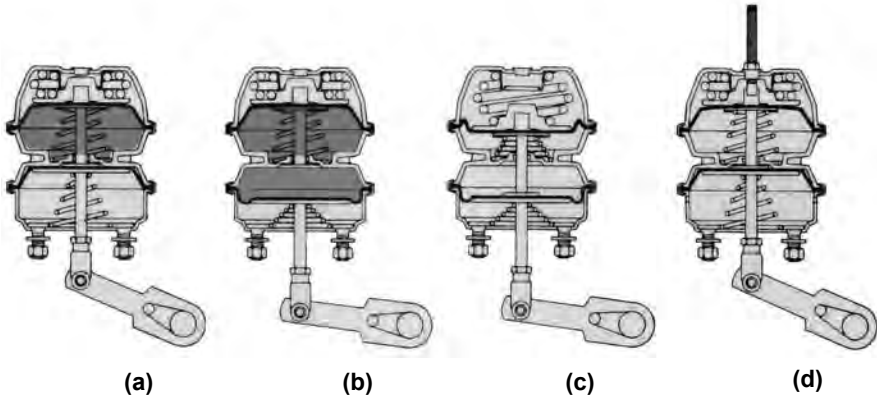

Figure 8

Most North American heavy-duty commercial vehicles have spring brakes installed on their drive axles only, while a typical trailer will have spring brakes on all axles. Service chambers are typically used on front axles.

SECTION 3

Maintenance

Spring brake chambers are an important part of the braking system. While they do not require scheduled servicing, it is good preventive maintenance to inspect the spring brake and service brake actuators externally to ensure they continue to perform within design specification. MGM Brakes recommends the following routine inspections whenever the equipment is in the shop for regular servicing, or at a minimum of every 50,000 miles.

It is important to note that virtually all spring brake chambers today have been mechanically sealed at the factory for your protection. There are no user serviceable parts inside the spring brake chamber, so you should never attempt to disassemble the unit for any reason. The spring brake contains a large, powerful spring with extreme force that could cause serious bodily injury if it were suddenly and inadvertently released. If the spring brake has failed or been damaged, remove either the entire actuator as described in *Section 7*, or the single (piggyback) as described in *Section 5*, and properly dispose of the unit as outlined in *Section 10*.

Identifying An MGM Brakes Product

All MGM brake actuators made after October, 1987 have an aluminum identification tag attached to the actuator that has the MGM Brakes part number, date of manufacture, and often a customer part number clearly stamped on it. Refer to the adjacent illustration for the location of the I.D. tag on the various models manufactured by MGM Brakes (**Fig. 9**).



Figure 9

MGM Brakes actuators are assigned a seven (7) digit part number that begins with a 1, 2, 3, 4 or 5, depending on the model, except for the magnum models that begin with the letter M: example: MJS, MJW and/or MJB.

Date codes simply show the month, day and year (MMDDYY) and are prefixed by the letter “C” (for Cloverdale, CA) and “M” (for Murphy, NC) which identifies the plant where the actuator was manufactured.

Example: M102999

- Letter prefix identifies the manufacturing plant
- First two digits identify the month of manufacture
- Second two digits identify the day of manufacture
- Final two digits identify the year of manufacture

Therefore, the brake in this example would have been manufactured in Murphy, North Carolina, on October 29th, 1999.

Externally, the MGM Brakes logo can be found on all die-cast aluminum cylinder cases and center sections, and on most stamped steel heads, pressure caps and non-pressure chambers. The MGM Brakes logo can also be found on the clamp bands and the plastic end cap.



Figure 10

Internally, the MGM Brakes logo can be found stamped on the mounting bolt heads and piston plates and embossed on the diaphragms.

External Inspection Points and Procedures

Before proceeding with the recommended inspection points, there are a few “common-sense” precautions that should be taken.

First, be sure you turn off the engine before working under any vehicle, and always “chock” (or block) the wheels. Depleting the air system pressure may allow the vehicle to roll. Also, remember to keep your hands away from the actuator push-rods and slack adjusters as they may apply as system pressure decreases.

Now, before you begin working on or around the spring brake chamber or the foundation system, take a few minutes to visually inspect the chamber to make sure it hasn't been damaged (**Fig. 10**). Brake chambers are positioned under the vehicle,



Figure 11a & b

close to the road, so they tend to take a lot of punishment. If you suspect the brake has sustained structural damage, for example the head is severely dented, DO NOT attempt to cage the brake. To reduce the possibility of serious injury when removing an uncaged actuator, use an acetylene gas torch to cut the service push-rod to relieve the pressure being applied to the slack adjuster. After the push-rod is cut, carefully remove the unit from the vehicle and disarm the spring brake by following the recommended disarming procedure as described in *Section 10* of this booklet.

NOTE: Commercial Vehicle Safety Alliance (CVSA) inspectors will place a vehicle out-of-service if “any non-manufactured holes or cracks in the spring brake housing section of a parking brake” are detected, so be sure to thoroughly inspect the brake.

Also, still on the subject of safe handling procedures, NEVER strike any part of a spring brake with a hammer or other heavy object and NEVER drop a spring brake as structural damage may result. Now you are ready to proceed with the inspection of the brake.

The first thing you want to inspect is the plastic END CAP or DUST PLUG (**Fig. 11a**). Make sure it is not damaged and that it is snapped tightly in-place, and, if it is designed to be attached to the head, it is securely attached. While these caps/plugs require no special positioning or maintenance, they must be snapped tightly into the release bolt access hole to prevent ingestion of large particles of contamination, such as grit and gravel. Failure to properly install the cap/plug can adversely effect the warranty on some models of spring brakes such as MGM Brakes models equipped with the external breather-tube. The END CAP on MGM Brakes TR-T and TR-TS model brakes are equipped with a rubber O-ring (**Fig. 12**) to help seal out moisture. Ensure the O-ring is free of damage and is properly positioned on the END CAP.

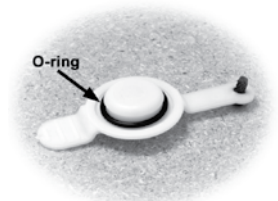

⚠ WARNING - Operating units equipped with the EXTERNAL BREATHING TUBE without the END CAP and O-RING securely in place will void the MGM Brakes Warranty without remedy.

Next, inspect the exterior surfaces of the spring brake for signs of damage or excessive corrosion. If any of these conditions are seen or suspected, carefully remove the combination/tandem brake by following the manufacturer’s recommended procedure. For MGM Brakes see *Section 7* of this booklet or refer to *Section 3* of the MGM Brakes TR Service Manual (Form #5011).

Be sure to inspect the VENT HOLES (**Fig. 11b**) in the head of the spring brake to ensure they are fully open and unrestricted. Brakes need to “breathe” when operating. When installed on vehicles operating in dump truck, ready-mix concrete and other similar operations, spring brakes can become encrusted with dirt or concrete which can prevent the circulation of air through the unit and entrap moisture and contaminants. If the holes are restricted, carefully ream the holes out by hand with a 3/8-inch drill bit (**Fig. 13**).



Figure 13

⚠ WARNING: DO NOT use a power drill as you may damage the diaphragm or other internal parts.

On units equipped with an EXTERNAL BREATHER-TUBE (**Fig. 14**), be sure to inspect the breather-tube and elbows for damage. Make sure the BREATHER-TUBE is inserted a minimum of 1/2-inch into each elbow and securely fastened with a high quality rubber adhesive or clamp.



Figure 14

NOTE: IMPORTANT - When installing any MGM Brakes model with the breather tube, it is mandatory to position the breather tube in the upper half, or upper quadrant (9:00 to 3:00 o'clock), facing away from the road surface (Fig. 15). Failure to comply will void the MGM Brakes Warranty without remedy on these models.

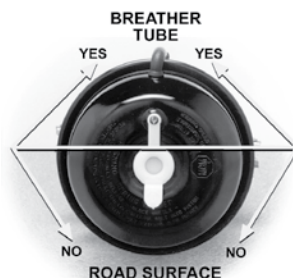

Figure 15

Inspect the SERVICE CLAMP BAND and CLAMP BAND EARS for damage and make sure the clamp band is securely in place. When properly torqued (30-35 Lbs.-Ft.), the clamp band ears should be parallel to each other (**Fig. 16b**), not angled or bent (**Fig. 16a**). If the ears appear to be over torqued, or damage is detected or suspected, cautiously remove the piggyback/spring brake chamber by following the directions in *Section 5* of this booklet.

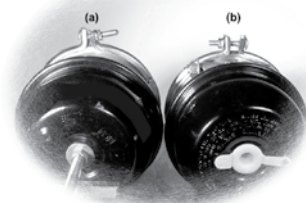

Figure 16

Next, check the actuator to be sure it is mounted solidly to the mounting bracket by placing one hand on the head of the brake and try to move the brake up and down or to the side (**Fig. 17**). The mounting stud nuts should also be properly tightened to the manufacturer's recommended specification. MGM Brakes recommends 133-155 Lbs.-Ft. of torque (clockwise). Check to be sure that the split lock-washers, or hardened-steel flat washers (used by MGM Brakes), are positioned properly in-place between the nut and the bracket. Placing the washers between the brake chamber and the bracket will allow the chamber to "flex", resulting in premature failure of the NON-PRESSURE CHAMBER.



Figure 17

Inspect the NON-PRESSURE CHAMBER (**Fig. 18**) for damage and/or cracks around the MOUNTING STUDS. If damage or cracks are evident, remove the complete chamber by following the directions in *Section 7* of this booklet or refer to *Section 3* of the MGM Brakes TR Service Manual (Form #5011). Inspect the VENT HOLES in the NON-PRESSURE CHAMBER to ensure they are fully open and unrestricted. If the holes are restricted, use a 3/8-inch drill bit and carefully ream the holes out by hand (**Fig. 13**).



Figure 18



WARNING: DO NOT use a power drill as you may damage the diaphragm or other internal parts.

Carefully inspect all air lines, hoses and fittings attached to the chamber (**Fig. 19**). Remove and replace any damaged or leaking parts. Remember, never disconnect any air hose or air line that contains air pressure as it may "whip" as the air escapes. Never remove a component or pipe plug unless you're absolutely sure that all system pressure has been depleted. Be careful to never exceed recommended air pressures. Always wear safety glasses while working with pressurized air and never look directly into air jets or direct them at anyone.



Figure 19

NOTE: North American Uniform Out-of-Service Criteria identifies the following items relating to air lines, hoses and fittings as cause to place any commercial vehicle "Out-of-Service":



Figure 20



Figure 21

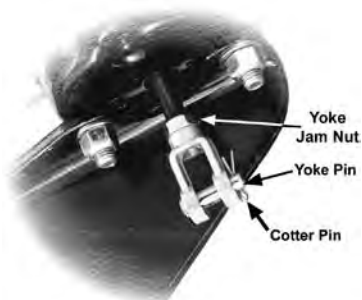

Figure 22

1. Any hose with damage extending through the outer reinforcement ply. Rubber impregnated fabric cover is not a reinforcement ply. (Thermoplastic nylon may have braid reinforcement or color difference between cover and inner tube. Any exposure of the second color is an out-of-service condition.)

2. Any hose with a bulge or swelling when air pressure is applied.

3. Any hose or tubing with an audible air leak anywhere other than at a proper connection.

4. Two hoses improperly joined, such as a splice made by sliding the hose ends over a piece of tubing and clamping the hose to the tube.

5. Any air hose or tubing that is damaged by heat or that is cracked, broken or crimped in such a manner as to restrict airflow.

Inspect the PUSH-ROD (**Fig. 20**) to be sure it is working freely, that it is not bent or binding, and is square to the chamber bottom within $\pm 3^\circ$ in any direction and at any point during the stroke of the chamber. If the PUSH-ROD is not square, make corrections by repositioning the chamber on the mounting bracket or by shimming the slack adjuster to the right or left of the camshaft as required.

On units equipped with a DUST BOOT (**Fig. 21**), check the BOOT for damage and replace as necessary.

Inspect the YOKE ASSEMBLY (**Fig. 22**). Make sure the YOKE PIN is installed and locked into place with a COTTER PIN. Replace any damaged, worn or missing parts. MGM Brakes recommends that the YOKE JAM NUT be tightened to 25-35 Lbs.-Ft. of torque.

And finally, before you come out from under the vehicle, visually inspect the foundation brake (**Fig. 23**) to make sure there are no loose, missing or broken mechanical components. Many commercial vehicles are placed "out-of-service" by *Commercial Vehicle Safety Alliance (CVSA)* inspectors for the following, highly visible problems:

1. Absence of effective braking action when air is applied to the service brakes, i.e. brake linings failing to move or contact the drum.
2. Missing or broken components such as brake shoes, brake drums, anchor pins and spiders.
3. Cracked, loose or missing brake lining or pads.
 - a. Lining cracks or voids 1/16-inch in width observable on the edge of the lining.
 - b. Portions of the lining segment missing so that a rivet or bolt is exposed when viewing the lining from the edge.
 - c. Loose lining segments with approximately 1/16-inch movement.
 - d. Complete lining segment missing.
4. Evidence of oil seepage onto or out of the brake lining or drum area. This includes wet contamination of the lining edge accompanied by evidence that further contamination will occur, such as oil running from the drum or bearing seal.



Figure 23

NOTE: Grease on the lining edge, back of shoe or drum edge and oil stains with no evidence of fresh oil leakage are not conditions for out-of-service consideration.

5. Any lining with a thickness less than 1/4-inch, or to wear indicator if lining is so marked, measured at the shoe center for drum brakes or less than 1/8-inch for disc brakes.
6. Absence of effective braking action on any steering axle of any vehicle required to have steering axle brakes, including the dolly and front axle of a full trailer.
7. Mismatch of chamber size or slack adjuster length across any power unit steering axle.

Recognizing and providing a remedy for these problems while the vehicle is in the shop can prevent costly down time.

SECTION 4

Manually Releasing The Brake

Before releasing the brakes, be sure to “chock” (or block) the wheels to prevent the vehicle from moving.

On units equipped with a REMOVABLE RELEASE BOLT, use a 3/4-inch (15/16-inch for type 3036 and 3636 models) wrench to remove the nut, flat washer and release-bolt from the storage pocket on the side of the chamber (**Fig. 24**). It is important to remember that these parts are essential to the release procedure and should be stored in the pocket provided, or in the glove or toolbox of the vehicle. The spring parking brake cannot be released without them.

Remove the plastic END CAP or DUST PLUG from the spring brake chamber (**Fig. 25**). Insert the RELEASE BOLT into the RELEASE BOLT ACCESS HOLE (**Fig. 26**) in the head of the brake. Be sure the formed end, or “tee” end, of the bolt has been properly inserted into the hole in the piston inside the chamber. Insert the RELEASE BOLT until it bottoms out, then turn (rotate) the bolt 1/4 turn clockwise. Now lift the bolt to lock the formed end into the piston. If the RELEASE BOLT does not lock into the piston within at least 1/2-inch of lift, remove the bolt and repeat the procedure. When you are sure the RELEASE BOLT is locked into the piston, hold it in position and install the flat washer and nut. Turn the nut down against the flat washer until finger tight (**Fig. 27**).



WARNING: If you are not absolutely sure that the bolt-to-piston engagement is correct, repeat this step until you are sure of positive engagement.

Now, using a 3/4-inch (15/16-inch for type 3036 and 3636 models) wrench (**DO NOT USE AN IMPACT-TYPE WRENCH**) turn the RELEASE BOLT NUT clockwise until the RELEASE BOLT thread extends above the nut (**Fig. 28**) indicating that the brake is at zero (0) stroke. Refer to the manufacturer’s specifications for proper measurement.



Figure 24



Figure 25



Figure 26



Figure 27



Figure 28

NOTE: For MGM Brakes TR, TR-T and TR-TS models use the following information as a guideline:

Type 2430 & 3030 Models	3.25-inches of thread above the nut
Type 3036 & 3636 Models	4.00-inches of thread above the nut

NOTE: It is essential that the brake being serviced be fully released to zero (0) stroke to assure that any measurements taken concerning rod length be correct should the decision be made to replace the complete unit. Improperly measuring the push-rod length ('X' & 'Y' dimensions) on the old rod may result in the push-rod on the replacement unit being cut to an incorrect length. This may result in premature failure of the center seal on the replacement unit. For example: If the brake being serviced was a type 3030 model and the technician "caged" the brake so that only 2.50 inches of the release-bolt thread protruded above the release-bolt nut, there would be approximately 3/4-inch of stroke remaining in the brake. Therefore, if the rod measurement of the brake being serviced were transferred to the replacement brake, the rod would be cut approximately 3/4-inch too long.

For MGM brakes equipped with an INTEGRAL RELEASE BOLT (Fig. 29), i.e. models LTR-T and LTR-L3, use a 15/16-inch wrench (DO NOT USE AN IMPACT-TYPE WRENCH) to turn the RELEASE BOLT counter-clockwise until the power spring is fully caged (Fig. 30).



Figure 29

NOTE: The service chamber push-rod must retract the same approximate distance the release bolt extends from the head of the brake. Use the following information as a guideline:

LTR-T (pre-6/1/98)	
2.25 - 2.5 inches	Type 24 and 30 Chambers
LTR-T (post-5/31/98)	
3.0 inch	Type 24 and 30 Chambers
LTR-L3	
3.0 inch	Type 24 and 30 Chambers



Figure 30



WARNING: DO NOT exceed any of these recommended lengths, and DO NOT exceed 50 Lbs.-Ft. of torque on the RELEASE NUT at any time or you may damage the RELEASE BOLT or other internal components which could prevent correct manual-release of the chamber.

NOTE: With MGM Brakes “Magnum” piston-type brakes, models MG-T and MJ-ET (Fig. 31), the spring brake is manually released by turning the release bolt counter-clockwise using a 3/4-inch deep socket wrench. The release bolt can be completely removed on MG-T models. However, MJ-ET units have a non-removable release bolt. Use the following recommendations when manually releasing MJ-ET models:



Figure 31

<u>Brake Stroke</u>	<u>Release Bolt Protrusion</u>
2.50" (Std.) Stroke	1.07"
3.00" (Long) Stroke	1.27"

Incidentally, the unscrewing and/or removal of the release bolt from MG-T models does not actually “cage” the power spring (as it does on MJ-ET units). This operation only removes the power spring force from the slack adjuster. To reinstall and/or retighten the release bolt in all piston-type models, apply line pressure to the spring brake and screw the release bolt completely into the chamber and tighten to 35-45 Lbs.-Ft. of torque (Fig. 32).

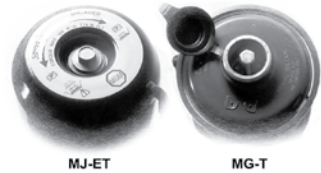

Figure 32

To make the manual release procedure easier on double-diaphragm brakes, you can apply 90-100 psi air pressure to the inlet port marked “SPRING BRAKE” prior to inserting the RELEASE BOLT, but be sure to exhaust all air pressure after establishing the proper amount of thread extends above the RELEASE NUT. To release the brake, reverse the order of operation.

After the brake has been released, re-install the RELEASE BOLT, FLAT WASHER and RELEASE NUT into the storage pocket on the side of the brake. MGM Brakes recommends applying 10 Lbs.-Ft. of torque to the nut against the flat washer.

SECTION 5

Replacing the Single/Piggyback Chamber

To begin with, make sure the wheels of the vehicle have been securely “chocked” (or blocked) to prevent the vehicle from moving. Now, manually, or with system air pressure, extend the service push-rod slightly and clamp it in place with vise grip pliers to prevent sudden separation of the single/piggyback from the service chamber when the clamp band is removed (**Fig. 33**).



Figure 33

Now, following the manufacturer’s recommended procedure, manually release, or cage, the spring brake.

Next, remove the SERVICE and SPRING BRAKE air supply lines from the chamber. Be sure to mark the air line connected to the inlet port marked “SPRING BRAKE” so it can be easily identified and properly connected to the correct inlet port during the installation process (**Fig. 34**).



Figure 34

If the brake is equipped with an EXTERNAL BREATHER-TUBE (**Fig. 35**), disconnect the tube from the rubber elbow. Because the tube is bonded to the rubber elbow by a rubber adhesive, it may be necessary to “roll” the rubber elbow away from the tube to achieve separation.



Figure 35

Now, you’re ready to remove the single/piggyback chamber. Using a 9/16-inch wrench, remove the CLAMP BAND NUTS on the SERVICE CLAMP BAND. Then, while holding the single/piggyback chamber securely in place with one hand, remove the CLAMP BAND (**Fig. 36**) and separate the spring brake from the service chamber.



Figure 36

Once you have removed the spring brake, take the opportunity to inspect all the parts in the service chamber and replace any parts that may be damaged or worn, especially the diaphragm and clamp band.

Before installing the new single/piggyback spring brake, make sure it is fully released to zero stroke. Now, position the new diaphragm into the bottom recess of the single/piggyback chamber (**Fig. 37**).

Then, paying close attention to assure all mating surfaces are in alignment and that the air inlet ports are properly positioned to mate with the vehicle air supply lines, install the new clamp band.

Install the new clamp band bolts and nuts and alternately tighten each nut in 5 to 10 Lbs.-Ft. torque increments while constantly rechecking the alignment of the mating parts. If re-alignment of the mating parts is required, loosen the clamp nuts and repeat the installation process. To help seat the clamp band, firmly tap around the circumference of the clamp band with a plastic or rubber hammer (**Fig. 38**) while alternately tightening the nuts to 30-35 Lbs.-Ft. of torque. Be sure to reinstall or replace any I.D. tags that may have been attached to the clamp band bolt, such as the 3-inch trapezoid identification tag, or the "Heavy Duty" identification tag.

Reinstall the air supply lines to the chamber, making sure each line is mated to the correct air inlet port (follow the identification marks made earlier). Be sure to apply a non-hardening sealing compound to the fittings and tighten them according to the manufacturer's recommended specifications. MGM Brakes recommends that the fittings be tightened to 25-30 Lbs.-Ft. of torque into the chamber air inlet ports.

Now, using the vehicle's system air, charge the parking brake with full line pressure (minimum 100 psi) and check for air leaks by applying soapy water or leak detection solution (**NEVER USE ANY TYPE OF OIL**) to the air lines and fittings. If bubbles appear around the fittings, tighten them slightly, but not over 30 Lbs.-Ft. of torque.



Figure 37



Figure 38

With the spring brake still fully charged with full line pressure, apply and hold the foot brake treadle valve down to charge the service brake chamber. At this time the vise-grip pliers can be removed from the service push-rod so that the piston can return to a normal position in the chamber. Now, apply soapy water or leak detection solution to the circumference of the service clamp band. If bubbles appear, firmly tap the circumference of the clamp ring with a hammer (**Fig. 38**) and retighten the clamp band nuts 30-35 Lbs.-Ft of torque until the leaks cease. However, if the leaks persist around the clamp band, release the air from the unit, loosen the clamp band and repeat the installation procedure.



Figure 39

If the new unit is equipped with an EXTERNAL BREATHER-TUBE, insert the end of the tube into the flexible rubber elbow extending from the NON-PRESSURE HOUSING to a minimum 1/2-inch engagement. Secure the tube in place using the hose clamps furnished with the unit, or, wipe the open end of the tube to be sure that no oil is present and apply a high quality rubber adhesive to the tube before inserting it into the rubber elbow (**Fig. 39**).

If the old single/piggyback unit was not equipped with an EXTERNAL BREATHER-TUBE, you will need to drill a 1/2-inch diameter hole 1-inch from the top lip of the non-pressure chamber to insert the connecting rubber elbow. Be sure to drill the hole at a point closest to the centerline between the air ports (**Fig. 40**).



Figure 40

NOTE: On brakes equipped with an EXTERNAL BREATHER-TUBE, the BREATHER-TUBE must be positioned in the upper half, or upper quadrant (9:00 to 3:00 o'clock), facing away from the road surface (Fig. 15). Failure to comply with these installation instructions will void the MGM Brakes Warranty without remedy.



Figure 41



Figure 42

Remove any metal burrs from around the newly drilled hole, and then install a new rubber elbow on the non-pressure chamber. Again, wipe the open end of the connector tube clean to be sure no oil is present, apply a high quality rubber adhesive to the end of the tube, and insert the tube into the flexible elbow to a minimum 1/2-inch engagement (**Fig. 39**).

Now, exhaust the air pressure from the service chamber, but maintain line pressure in the spring brake. Remove the **RELEASE BOLT**. Snap the plastic **END CAP** or **DUST PLUG** tightly into the release-bolt access hole. Use the **RELEASE BOLT** to press the **END CAP** securely into place (**Fig. 41**). Install the **RELEASE BOLT**, **NUT** and **WASHER** into their storage pocket (**Fig. 42**) on the side of the chamber (or put them into the vehicle tool box or glove box). Tighten the **RELEASE NUT** against the flat **WASHER** to 10 Lbs.-Ft. torque. If the spring brake chamber is equipped with an integral release bolt (**Fig. 29**), use a 15/16-inch wrench (**DO NOT USE AN IMPACT WRENCH**) and simply turn the release bolt clockwise until the bolt is fully engaged into the unit and the slotted nut bottoms out. Tighten the nut to 45-50 Lbs.-Ft. of torque.

SECTION 6

Removal and Replacement of the Service Diaphragm



Figure 43

Often, when a leak is detected in the service side of the spring brake (service brake chamber), the problem can be corrected by simply replacing the SERVICE DIAPHRAGM (Fig. 43).

To begin with, make sure the wheels of the vehicle have been securely chocked (or blocked) to prevent the vehicle from moving. Now, manually (or with system air pressure) extend the service push-rod slightly and clamp it in place with vise-grip pliers to prevent sudden separation of the single/piggyback from the service chamber when the clamp band is removed (Fig. 44).



Figure 44

Be sure to “cage” the single/piggyback spring brake before removal following the procedures outlined in *Section 4* of this booklet or in *Section 2* of the MGM Brakes TR Service Manual, Form #5011.

NOTE: In many cases it may not be necessary to disconnect the air lines from the spring brake during the diaphragm replacement procedure as long as correct and straight parts alignment can be obtained during the re-assembly operation.

Next, should you decide to remove the SERVICE and SPRING BRAKE supply lines from the single/piggyback chamber, be sure to mark the air line connected to the inlet port marked “SPRING BRAKE” (Fig. 45). This way it can be easily identified and properly connected to the correct inlet port during the reinstallation process. If the brake is equipped with an EXTERNAL BREATHER-TUBE, disconnect the tube from the rubber elbow (Fig. 46). Because the tube is bonded to the rubber elbow by a rubber adhesive, it may be necessary to “roll” the rubber elbow away from the tube to achieve separation.



Figure 45



Figure 46

Now, you're ready to remove the single/piggyback from the service chamber. Using a 9/16-inch wrench, remove the CLAMP BAND NUTS on the SERVICE CLAMP BAND. Then, while holding the single/piggyback chamber securely in place with one hand, remove the CLAMP BAND (**Fig. 47**) and separate the spring brake from the service chamber.

Remove and discard the old service diaphragm. Carefully inspect all visible components for damage, i.e. return spring, piston plate, non-pressure chamber and flange case. Replace any severely worn or damaged components.

Place a new diaphragm into the cavity of the single/piggyback chamber flange case (**Fig. 48**) and align the single/piggyback with the non-pressure chamber.

Install a new clamp band and tighten the nuts finger tight to hold the single/piggyback in place. Now, using a plastic or rubber mallet, tap the clamp band around its circumference while alternately tightening the clamp band nuts in 5-10 Lbs.-Ft. torque increments (**Fig. 49**). Constantly checking the alignment of the mating parts during this operation will ensure proper seating. MGM Brakes recommends tightening the clamp band nuts to 30-35 Lbs.-Ft. of torque. Be sure to reinstall or replace any I.D. tags that may have been attached to the clamp band bolt, such as the 3-inch trapezoid identification tag or the "Heavy Duty" identification tag.

Now you can apply air pressure to the service chamber and, using soapy water (**NEVER USE ANY TYPE OF OIL**) or leak detection solution, check for air leaks. If leaks are detected, repeat the clamp band installation procedure.

When you are satisfied that there are no leaks, remove the vise-grip pliers from the service chamber push-rod.



Figure 47



Figure 48



Figure 49

SECTION 7

Removing the Combination/Tandem Brake

Before you start to remove the combination/tandem brake from the vehicle, be sure to inspect the brake for any damage following the procedure in *Section 1* of this booklet or *Section 3* of the MGM Brakes TR Service Manual, Form# 5011.

Once you are sure the brake has not been damaged and can be safely handled, determine the manufacturer of the combination/tandem chamber you will be removing from the vehicle and manually release the spring brake completely following the manufacturer's instructions. Instructions for all MGM Brakes Model-Series TR, TR-T and TR-TS spring brakes are given in *Section 2* of the MGM Brakes TR Service Manual (Form #5011). Service Manuals for all other design-series of spring brakes are also available upon request from MGM Brakes.

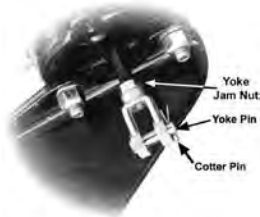

Figure 50

Remove the cotter pin from the yoke pin, then knock out the yoke pin (**Fig. 50**). If the yoke pin is rusted (frozen) into the yoke, it may be necessary to use an acetylene gas torch to remove the pin. Be sure to observe all safety precautions when operating an acetylene gas torch and wear proper protective clothing and eye protection.



Figure 51

Next, remove both air supply lines from the assembly, making sure to note which air line was connected to the inlet port marked "SPRING BRAKE". This is important for later reinstallation reference. Masking tape and a felt-tip marker are handy for this purpose (**Fig. 45**).

Using a 15/16-inch wrench, unscrew the hex nuts on the mounting bolts and cautiously remove the old chamber from the mounting bracket (**Fig. 51**).

Make sure the spring chamber of the removed actuator is fully released (power spring caged) and the service brake push-rod is fully retracted to zero (0) stroke position (i.e., brake fully released). If the power spring is broken and installation of the release tool is impaired due to the angle of the piston, apply 90-100 psi air pressure to the inlet port marked "SPRING BRAKE". Unless there

is a severe air leak, this should “cage” the brake, allowing insertion of the release tool into the piston. Install the flat washer and nut, and tighten the nut finger tight. Be sure to exhaust all air pressure once the brake has been “manually” caged.

SECTION 8

Procedure to Cut the Universal Service Push-Rod

Carefully and accurately measure and record the “X” and “Y” dimensions. The “X” Dimension is measured from bottom of actuator to end of piston rod, while the “Y” Dimension is measured from bottom of actuator to centerline of yoke pin (Fig. 52).



Figure 52

NOTE: If, for some reason, the release tool cannot be properly inserted into the piston and the brake cannot be caged either manually or with air pressure, then the “X” and “Y” dimensions will need to be obtained from another “like” chamber on the same vehicle. However, it is important to verify that the chamber selected is an “original” equipment installation, or, a replacement chamber, that the push-rod has been cut to the proper length. If the vehicle is equipped with “automatic” slack adjusters, this can be established by using the slack adjuster set-up template to verify the correct angle between the slack adjuster arm and the push-rod. Be sure the chamber being used has been fully retracted to its zero (0) stroke position before taking any measurements. Then the “X” and “Y” dimensions can be taken from that unit. Otherwise, since dimensions vary between automatic and manual slack adjusters, slack lengths and different manufacturers, it will be necessary to refer to the vehicle manufacturer’s recommendation for the correct angle between the slack adjuster arm and push-rod and/or the push-rod length.

Failure to fully cage (release) the failed unit to zero (0) stroke before taking either the “X” or “Y” dimension measurement will result in the push-rod on the new unit being cut to an operational length longer than required. The additional length will be equal to the distance remaining within the old chamber needed to achieve zero (0) stroke. The extra rod length will have a negative effect on the life of the brake, causing among other things, premature failure of the center section seal and excessive contact between the push-rod and the push-rod hole in the non-pressure housing. In some cases, the additional push-rod length has contributed to the cracking and eventual failure of the non-pressure housing at the mounting studs, or even the failure of the mounting bracket.

Before marking the push-rod to be cut on the new unit, be sure the spring chamber and push-rod are fully retracted to the zero (0) stroke position. This may be done with the release (or caging) bolt or by applying 90-100 psi air pressure to the spring chamber air inlet port. Then, take the measured “X” dimension from the removed unit and mark the push-rod of the new unit from the bottom of the actuator (Fig. 53).

Next, thread the yoke jam nut past the mark you made on the push-rod and align the bottom edge of the nut with the mark. Use a hacksaw to cut the push-rod on the mark (**Fig. 54**). After cutting the rod, turn the jam nut off the rod to clean up the cut thread.

Replace the jam nut back onto the push-rod at a sufficient length to allow installation of the yoke, and thread the yoke onto the push-rod (**Fig. 55**). It is possible to reuse the yoke from the old unit provided yoke-pin hole is not worn. Adjust the yoke to the same “Y” dimension as measured from the old unit. Be sure to hold the yoke to prevent it from turning and tighten jam nut against the yoke to 25-35 Lbs.-Ft. of torque.

NOTE: If the unit being replaced is an MGM Brakes 3-Inch “Long Stroke” brake, there is a chance that the unit may have the MGM Brakes “Welded Yoke” (Fig. 56) attached to the push-rod, making removal and re-use of the yoke impossible. Therefore, unless the non-pressure housing (mounting base), push-rod, and/or yoke have been damaged or are severely worn, MGM Brakes recommends replacement of the single/piggyback unit only. Be absolutely sure that you replace the 3-inch “Long Stroke” piggyback with a 3-inch “Long Stroke” replacement unit. Mixing 2.5-inch “standard stroke” chambers with 3-inch “Long Stroke” chambers across an axle is not recommended. In addition, it is essential that the correct diaphragm be used when servicing a 3-inch “Long Stroke” chamber. Obviously, a 2.5-inch “standard stroke” diaphragm will fit into the service side of a 3-inch “Long Stroke” chamber. However, the performance characteristics of the “Long Stroke” chamber will be adversely affected. If replacement of the complete/tandem unit is required, MGM Brakes recommends using a replacement unit with the “Welded Yoke”.



Figure 53



Figure 54



Figure 55



Figure 56

SECTION 9

Reinstalling the Combination/Tandem Brake

Remove the hex nuts and the flat washers from the mounting bolts of the new chamber. Prior to installing the new combination/tandem brake, take a few minutes to inspect the mounting bracket to insure the bracket surface is free of all cracks, burrs and debris that may prevent the brake from mounting flush to the bracket's surface (Fig. 57).



Figure 57

Now, install the new chamber on the bracket, paying close attention to positioning the chamber air inlet ports for correct alignment to the vehicle air supply lines (Fig. 58). **Make sure you mount the brake directly to the bracket. DO NOT use any spacers, washers or shims between the mounting bracket and the non-pressure housing.** Install one flat washer and hex nut on each mounting bolt, and, using a 15/16-inch hand wrench (**DO NOT USE AN IMPACT-TYPE WRENCH**), tighten the nuts to the MGM Brakes recommended 133-155 Lbs.-Ft. of torque (Fig. 59).



Figure 58

NOTE: If repositioning of the air inlet ports is required to assure proper mating and alignment with vehicle air lines with the inlet ports, follow the procedure outlined in *Section 5* of this booklet, or in *Section 4* of the MGM Brakes TR Service Manual (Form #5011). The air lines should line up directly with the inlet ports and there should be no sharp bends or "kinks" in the air lines. **DO NOT** use a 90° elbow fitting as this may restrict air flow and affect the performance of the unit.



Figure 59

NOTE: IMPORTANT - When installing any MGM Brakes model with the breather tube, it is mandatory to position the breather tube so that it faces away from the road surface (Fig. 60). Failure to comply will void the MGM Brakes Warranty without remedy on these models.



Figure 60

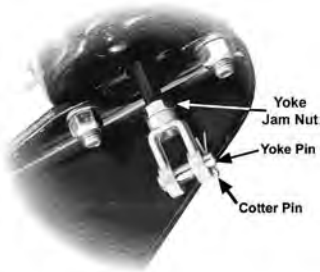

Figure 61

Now you can reconnect the yoke to the slack adjuster, being sure that the correct diameter and length of yoke pin is installed into the correct hole in the slack adjuster. Be sure to secure the yoke pin with a new cotter pin (Fig. 61).



Figure 62

Inspect the push-rod to be sure that it is working free, not bent or binding, and is square to the chamber bottom, within $\pm 3^\circ$ in any direction at any point in the chamber stroke (Fig. 62). If the push-rod is not square, make corrections by repositioning the chamber on the mounting bracket and/or by shimming the slack adjuster to the right or left on the camshaft as required (Fig.63).



Figure 63

Apply a non-hardening, sealing compound to the hose fittings and reinstall both air lines to the chamber (Fig. 64). Be sure that each fitting is mated to the correct air inlet port according to markings made earlier. **MGM Brakes recommends the fittings be tightened to 25-30 Lbs.-Ft. of torque into the chamber air-inlet ports.** Using the vehicle's system air, charge the spring brake with full line pressure (minimum 100 psi). Using only soapy water or leak detection solution (**NEVER USE ANY TYPE OF OIL**), inspect for air leaks at the air supply lines and fittings. If bubbles appear, tighten fittings slightly, but not over 30 Lbs.-Ft. of torque.



Figure 64



Figure 65

NOTE: If the service brake clamp band was loosened to reposition the air inlet ports, apply air to the spring brake and then apply and hold foot brake treadle valve down to charge the service brake chamber. Test for air leaks around the circumference of the service clamp band. If bubbles appear, release the air from the chamber and, using a plastic hammer or rubber mallet, firmly tap the circumference of the clamp band (Fig. 65) while alternately tightening the clamp band nuts to 30-35 Lbs.-Ft. of torque. Repeat the leak test procedure. If no more leaks are detected, exhaust the air from the “service” side of the unit. Now, with air still applied to the “spring brake” side, remove the release bolt, nut and washer.



Figure 66

Replace the END CAP or DUST PLUG. Use the RELEASE BOLT to seat the END CAP or DUST PLUG securely (Fig. 66). Operating units equipped with the EXTERNAL BREATHING TUBE not having the END CAP (with O-RING) securely in place will void the MGM Brakes warranty without remedy.

Next, place the release bolt, nut and washer securely into the storage pocket (Fig. 67) on the chamber. Tighten the nut against the flat washer to 10 Lbs.-Ft. of torque (Fig. 68). The release bolt can also be stored in the vehicle toolbox or glove box. Be sure to completely exhaust the air from both sides of the chamber when finished.



Figure 67



Figure 68

If the chamber is fitted with an external breather tube, be sure both ends of the tube are engaged a minimum of 1/2-inch into each of the flexible rubber elbows (**Fig. 69**). The tube must be securely fastened into both elbows, either by applying a high-quality rubber adhesive or with hose clamps.



Figure 69

NOTE: IMPORTANT - When installing any MGM Brakes model with the breather tube, it is mandatory to position the breather tube in the upper half, or upper quadrant (9:00 to 3:00 o'clock), facing away from the road surface (Fig. 60). Failure to comply will void the MGM Brakes Warranty without remedy on these models.

SECTION 10

Recommended Disposal Procedure



Figure 70

The proper disposal of old spring brake chambers is a concern of every fleet maintenance department and repair shop throughout the industry. All retired spring brake actuators must be safely disarmed before they are disposed of to prevent serious personal injury from accidental sudden release of the high-energy spring (as much as 2700 lbs. of force) in the parking chamber.

MGM Brakes has always recommended that the coils of the power spring be cut with an acetylene gas torch prior to disposal, as outlined in MGM Brakes Technical Bulletin #P1296. This simple procedure renders the power spring inoperable, permitting the chamber to be safely discarded.

Place the single/piggyback or combination/tandem unit in a properly constructed steel container* (Fig. 70). The container must have openings to expose the head where it is to be cut with an acetylene gas torch. It must also be strong enough to prevent parts from hurtling out should the unit suddenly separate before it is safely disarmed.

NOTE: Be sure to perform the disposal process in a well ventilated area. Fumes generated by the use of an acetylene torch may be harmful. DO NOT BREATHE THE FUMES!

NOTE: It is the user's responsibility to ensure the steel container is safe.

Position the chamber so the head can easily be accessed through the holes in the container. Depending on the size of the container, it may be necessary to cut the service push-rod in order to fit a combination/tandem spring brake into the container/disarming box.



WARNING: Never operate an acetylene gas torch without wearing proper clothing and eye protection.

Next, through one of the openings in the side of the container, use an acetylene gas torch to cut a hole (1-1/2 to 2 inches in diameter) in the head of the brake to expose the power spring. At this point, DO NOT cut the power spring. Repeat the process through the opening on the opposite side of the container. Cutting two holes opposite each other provides the torch with sufficient oxygen for the cutting of

the power spring. Now, use the torch to completely cut through one of the coils of the exposed power spring. Cutting the first coil may produce a low pitched “pop” or may cause the brake to jump in the box. Repeat the process through the opening on the opposite side of the container.



WARNING: DO NOT cut the clamp band bolts before cutting the power spring coils.



WARNING: Before discarding, submerge unit in water to cool. If unit is not cooled, it may continue to emit harmful fumes and could start a fire if placed near combustible material.

To make sure you have completely cut the power spring coils, use a screwdriver or similar tool to check that the coils are loose inside the head of the brake. **DO NOT PLACE YOUR HANDS OR FINGERS INSIDE THE CONTAINER.** If the coils can be moved, the brake has been rendered harmless and can be discarded.

MGM Brakes does not rebuild nor condone the use of rebuilt air brake actuators. This is because they are very important safety devices that actuate foundation brakes and perform vital parking and emergency brake functions. Because they operate in the worst possible environments under the most severe conditions, it is impossible to accurately determine the condition and service life remaining in critical components such as the non-pressure housing (mounting base), flange case (center section), power spring and center push-rod seal. These are all components that are typically “cleaned up” and/or repainted and reused in rebuilt actuators. Basically, with a rebuilt actuator, you have no reliable way of knowing which components have been replaced and how long the unit can be expected to last.

****Information concerning where to obtain a suitable container is available from your MGM Brakes representative or on our website, [www.MGMBrakes.com/publications.cfm#master, form# P1296](http://www.MGMBrakes.com/publications.cfm#master,form#P1296).***

SECTION 11

Brake Adjustment

Proper brake adjustment is critical to the safe operation of commercial vehicles. “Out-of-Adjustment” brakes are the single most cited reason for commercial vehicles to be placed “Out-of-Service” throughout North America during roadside inspections.

Obviously, truck-trailer combinations do not “stop on a dime”. Tests have shown that a fully loaded truck-trailer with fully adjusted cold brakes (200°F drum temperature) traveling at a speed of 60 MPH under the best of road conditions, required an average of 342 feet of stopping distance. The chart below (**Fig. 71**) demonstrates the average distances required to stop a truck/trailer traveling at various speeds.

SPEED vs. TOTAL STOPPING DISTANCE											
SPEED		PERCEPTION + REACTION DISTANCE				+	“BRAKE LAG” DISTANCE	+	EFFECTIVE BRAKING DISTANCE	=	TOTAL STOPPING DISTANCE
MILES PER HOUR	FEET PER SEC.										
15	22.0	33'	8'	11'	53'						
20	29.3	44'	10'	20'	74'						
25	36.6	54'	13'	31'	98'						
30	44.0	66'	16'	45'	127'						
40	58.6	88'	21'	80'	189'						
50	73.2	110'	25'	125'	260'						
55	80.6	120'	28'	150'	298'						
60	88.0	132'	30'	180'	342'						

Figure 71

- Average Driver Perception Time = .75 Seconds
- Average Driver Reaction Time = .75 Seconds
- Total Driver Perception And Reaction Time = Distance Traveled In 1.5 Seconds
- Average “Brake Lag” Distance (Time For Air To Pass Through a System in Good Working Order) = Distance Traveled In .27 Seconds
- Effective Braking Distance = Feet Traveled After Brakes Make Contact With Drums (With Good Braking Efficiency On Good Dry Pavement) the Coefficient of Friction = .8 Deceleration Rate @ 19.3 Feet Per Sec. Average
- Distances Based Upon a Fully Loaded Tractor-Trailer

NOTE: These are the best possible stopping distances. Under “average” conditions these distances will increase considerably.

Under the same test conditions at 60 MPH, except that the brakes were adjusted to the CVSA accepted readjustment limit, the stopping distance increased to 458 feet. Considering that the brakes may be well out of adjustment, the potential for disaster suddenly becomes all too real.

“OUT-OF-SERVICE” 20% GUIDE			
NUMBER OF AXLES	NUMBER OF BRAKES	20%	NUMBER OF BRAKES REQUIRED FOR OUT-OF-SERVICE
6	12	2.4	2.5
5	10	2.0	2.0
4	8	1.6	2.0
3	6	1.2	1.5
2	4	0.8	1.0

Figure 72

Currently, CVSA inspectors will immediately place a truck-trailer combo “Out-of-Service” if the number of defective (out-of-adjustment) brakes is equal to or greater than 20 percent of the brakes on the vehicle or combination (truck and trailer combined) (**Fig. 72**).

BRAKE ADJUSTMENT					
PASSENGER'S SIDE	1 1/2"	1 1/2"	1 1/4"	2"	2"
AXLE	1 (STEER AXLE)	2 (DRIVE AXLE)	3 (DRIVE AXLE)	4 (TRAILER AXLE)	5 (TRAILER AXLE)
DRIVER'S SIDE	1 1/2"	1 3/4"	2 1/8"	2 1/8"	2 1/4"
	TYPE 24	TYPE 30			
	CLAMP TYPE CHAMBERS				

Figure 73

Any defective (out-of-adjustment) brake that is less than 1/4-inch beyond the readjustment limit will count as 1/2 brake toward the 20% out-of-service rule, while any brake 1/4-inch or more beyond the readjustment limit will count as one (1) defective brake.

Example:

In this example (**Fig. 73**), the brakes on Axles 1 and 2 are within the recommended readjustment limit. The brakes on the driver’s side of Axles 3 and 4 are 1/8th of an inch over the recommended readjustment limit for a type 30 chamber. Each will count as 1/2 brake toward the 20% rule, for a total of one (1) full brake. The brake on the driver’s side of Axle 5 is 1/4 inch beyond the recommended readjustment limit and counts as one (1) full brake. Therefore, the total number of defective brakes totals two (2) on this five (5) axle vehicle, placing the vehicle “out-of-service” under the 20% rule.

NOTE: A brake found at the adjustment limit is not in violation.

See Cam Brake Adjustment Chart below (Fig. 74 & 75) for important information.

**CAM BRAKE ADJUSTMENT - ALL MODELS
SPRING BRAKE AND SERVICE BRAKE ACTUATORS**

NOTE: The last half of an air chamber stroke is less efficient than the first half. Therefore, the following adjustments are recommended for maximum efficiency when using manually adjusted slack adjusters.

BRAKES "OFF" – NOT APPLIED

Angle must always be greater than 90° due to various slack adjuster lengths and installation setups. (Refer to axle or Original Equipment Manufacturer's manual for recommended angle)

Stroke should be as short as possible with no lining to drum contact.

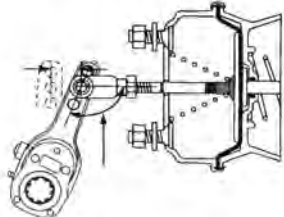

PROPERLY ADJUSTED BRAKES "ON" – APPLIED

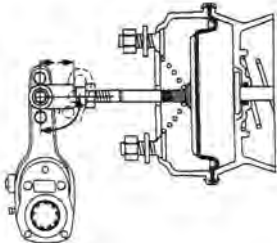

To check brake adjustment, apply 90 to 100 psi air pressure to the service chamber. Consult the vehicle manufacturer for the correct angle between the slack adjuster arm and push-rod and/or the push-rod length. This is necessary since different dimensions are required for automatic or manual slacks, various slack lengths and different slack adjuster manufacturers.

IMPROPERLY ADJUSTED BRAKES "ON" – APPLIED

Maximum recommended readjustment stroke has been exceeded.

See Recommended Readjustment Stroke chart on next page (Fig. 75).

MGM Brakes
"Stroke Alert"
(Excessive
Stroke Warning)

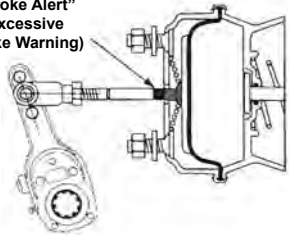

Figure 74

RECOMMENDED READJUSTMENT STROKE

TYPE	EFFECTIVE AREA	APPROX. DIAPHRAGM O.D.		RATED STROKE OF CHAMBER		MAXIMUM STROKE WITH BRAKES ADJUSTED	"B" MV/MA RECOMMENDED READJUSTMENT STROKE	
	Sq. Inches	Inches	MM	Inches	MM		Inches	MM
9	9	5.00	125	1.75	45	SHOULD BE AS SHORT AS POSSIBLE WITHOUT LINING TO DRUM CONTACT (BRAKES DRAGGING)	1.35	35
12	12	5.50	140	1.75	45		1.35	35
16	16	6.00	150	2.25	57		1.75	45
16L	16	6.00	150	2.50	64		2.00	51
20	20	6.50	165	2.25	57		1.75	45
20L	20	6.50	165	2.50	64		2.00	51
24	24	7.00	175	2.25	57		1.75	45
24L	24	7.00	175	2.50	64		2.00	51
24LP3	24	7.00	175	3.00	76		2.50	64
30	30	8.00	200	2.50	64		2.00	51
30LP3	30	8.00	200	3.00	76		2.50	64
36	36	9.00	230	3.00	76		2.25	57

SOURCE: MVMA (Motor Vehicle Manufacturers Association)

Note: The push-rod must remain perpendicular to the bottom surface of the non-pressure chamber (NPC) within $\pm 3^\circ$ zero to full stroke.

Figure 75

SECTION 12

3-Inch “Long Stroke” Brakes

Elevated brake temperatures are a major factor in the loss of braking effectiveness. We have seen how stopping distances were adversely affected by the increase in stroke caused by improper brake adjustment. Now, consider the increase in stroke brought on by the heat-induced expansion of the brake drum. If the temperature of the drums on the same test vehicle were raised to a realistic operating temperature of 600° F, the stopping distance would increase to approximately 692 feet, even though the brakes were adjusted to the CVSA limit.



Figure 76

You can see that even though the brakes were technically “in adjustment”, the influence of heat on the chamber stroke, in conjunction with normal brake lining fade, more than doubled the stopping distance. That is why 3-inch “Long Stroke” brakes (**Fig. 76**) have become one of the hottest topics in the trucking industry today. The bottom line for the use of “Long Stroke” brakes is safety. Even with proper maintenance and the incorporation of automatic slack adjusters, vehicles equipped with standard (2.5-inch) stroke chambers can still suffer a loss in braking performance. MGM Brakes, along with the American Trucking Association, the National Highway Traffic Safety Administration (NHTSA) and other industry leaders have worked very closely with CVSA on the “Long Stroke” concept.

Because of the performance benefits, CVSA has increased the “Out-of-Adjustment” criteria for 3-inch “Long Stroke” brakes to 2.5 inches compared to 2 inches for standard (2.5-inch) stroke chambers. Due to this additional allowance in stroke, it is extremely important that you know how to identify “Long Stroke” chambers.

Identification

All “Long Stroke” chambers are identifiable by square ports, trapezoidal I.D. tags and permanent markings (**Fig. 77**).

NOTE: IMPORTANT - When servicing a truck/trailer equipped with 3-Inch “Long Stroke” actuators, it is crucial that you replace like for like and do not install a standard stroke actuator in place of a “Long Stroke” actuator.

“Long Stroke” Spring Brake Identification

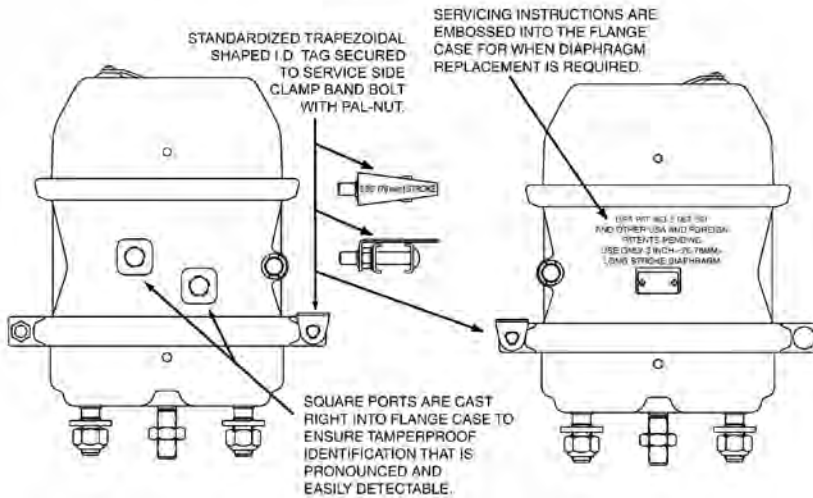

Figure 77

Installing a “standard stroke” (2.5-inch) chamber in place of a “Long Stroke” (3-inch) chamber can produce an imbalance in the stopping capability of the vehicle when the “standard stroke” chamber exceeds its recommended (2-inch) readjustment point. In addition, during a roadside inspection, the inspecting officer, coming into contact with the 2.5-inch “standard stroke” chamber at the beginning of his inspection, may assume that the remaining chambers on the vehicle are also 2.5-inch “standard stroke” and conduct his inspection accordingly. Therefore, although the remaining chambers have a readjustment limit of 2.5-inches (and are NOT in violation when beyond 2-inches of stroke), they could be “cited” by the officer for being “out-of-adjustment”, resulting in the vehicle being placed “Out-of-Service”.

To identify that a vehicle is fitted with 3-inch Long Stroke spring brakes, MGM Brakes has made available an identification decal (**Fig. 78**). This decal should be affixed to both sides of the vehicle's frame rail forward of the first drive axle so that it is visible to the inspecting officer. If the vehicle is not equipped with the decals, they can be obtained by contacting MGM Brakes.



Figure 78



WARNING: When replacing the service diaphragm of a “Long Stroke” chamber, you **MUST** replace with a 3-inch “Long Stroke” diaphragm. Using the incorrect diaphragm will change the performance characteristics of the actuator, adversely effecting its operating efficiency, which could result in catastrophic failure of the actuator.

Notes

Final Review

Congratulations. You have completed the MGM Brakes **BrakeTECH SERVICE Self-Study Training Program**, and now you are ready to test your knowledge about the maintenance and repair of brake actuators.

To begin, remove the perforated Mail-In Quiz Form answer sheet from the back of the booklet.

Next, read the quiz questions on pages 47-61, circling your choice for the best answer for each question.

Finally, use a black or blue ink pen and completely darken the box on the Mail-In Quiz Form which corresponds to each question. This will allow us to more efficiently process your quiz. Make sure you answer each and every question; **unanswered questions will be graded as incorrect.**

When you have finished, fold your answer sheet as indicated and tape or staple it closed; no envelope is required. Attach the proper postage and send your Mail-In Quiz Form back to MGM Brakes. Please allow at least four weeks for grading.

Participants scoring 85% or better will have successfully completed the **BrakeTECH SERVICE Self-Study Training Program** and will receive a Certificate of Completion from MGM Brakes, along with a **BrakeTECH SERVICE** patch. These tokens of our appreciation for a job well done will go one step further toward singling you out in the eyes of your colleagues and customers as a true expert on MGM Brakes products and the service procedures associated with them.

Participants failing to score the required 85% will be sent a letter of encouragement, along with another booklet. MGM Brakes will allow such a participant to make a second effort to succeed with the **BrakeTECH SERVICE Self-Study Training Program**.

Quiz Questions

Section 1

1. The actual braking function is performed by the _____.
 - A. brake drum
 - B. foundation brake
 - C. spring brake
 - D. brake shoes
 - E. slack adjuster

2. The foundation brake consists of the _____.
 - A. brake drum, spider, brake shoes & linings
 - B. camshafts, return springs, anchor pins & rollers
 - C. brake chamber, slack adjuster, air lines & fittings
 - D. A & B
 - E. None of the above

3. The _____ converts air pressure into mechanical pressure.
 - A. return springs
 - B. slack adjuster
 - C. brake shoes
 - D. brake chamber
 - E. None of the above

4. There are _____ types of air-operated foundation brakes used on medium- and heavy-duty trucks.
 - A. two
 - B. three
 - C. four
 - D. five
 - E. six

5. The three types of air-operated foundation brakes are _____.
 - A. vacuum, hydraulic & cam
 - B. hydraulic, wedge & cam
 - C. cam, wedge & disc
 - D. cam, wedge & vacuum
 - E. All the above

6. The slack adjuster converts air pressure into mechanical pressure.
True False

-
7. Like cam brakes, disc brakes utilize a slack adjuster to transfer force.
True False
8. Wedge brakes utilize a bushing and roller assembly to spread the brake shoes and force the lining against the drum.
True False
9. Disc brakes consist of a rotor, hub, wheel and caliper.
True False
10. The caliper is an assembly that positions the brake pads relative to the rotor.
True False

Section 2

11. The _____ functions independently of the spring brake chamber.
- A. master brake
 - B. service brake
 - C. slave brake
 - D. wedge brake
 - E. A & C
12. Spring brakes function as _____.
- A. service brakes
 - B. emergency brakes
 - C. parking brakes
 - D. All the above
 - E. None of the above
13. The _____ performs the normal slowing and stopping function.
- A. treadle valve
 - B. service brake
 - C. spring brake
 - D. relay valve
 - E. None of the above

-
14. The parking/emergency brake contains a _____.
- A. diaphragm, piston & lock ring
 - B. diaphragm, piston & o-rings
 - C. diaphragm or piston, & large powerful spring
 - D. diaphragm, piston & drive nut
 - E. None of the above
15. _____ are the two main types of spring brakes commonly used on trucks, buses, trailers and other types of heavy-duty commercial vehicles throughout the world.
- A. Double-diaphragm & piston-diaphragm
 - B. Air over hydraulic and double-diaphragm
 - C. Piston-diaphragm & roto-lock
 - D. Double-diaphragm & single roll diaphragm
 - E. None of the above
16. The service push-rod is connected to the foundation brake via a yoke and slack adjuster.
- True False**
17. A spring brake has two chambers: service brake chamber and parking brake chamber.
- True False**
18. The parking/emergency brake chamber contains a large, powerful spring.
- True False**
19. Double diaphragm brakes are the only types of spring brake used on trucks, buses, trailers and other heavy-duty commercial vehicles today.
- True False**
20. To park the vehicle, air is applied to the parking brake through a valve mounted on the vehicle's dash.
- True False**

Section 3

21. Before proceeding with the recommended inspection procedure, be sure to _____.
- A. totally deplete the air system and manually release the brakes
 - B. turn off the engine and "chock" (or block) the wheels
 - C. manually release the brakes and engage the transmission
 - D. turn off the engine and manually release the brakes
 - E. None of the above

-
22. A CVSA inspector will _____ if any non-manufactured holes or cracks have been detected in the spring brake housing section of the parking brake.
- A. ask you to adjust the brakes
 - B. place the vehicle "Out-of-Service"
 - C. provide a replacement brake
 - D. allow the vehicle to continue operation
 - E. None of the above
23. On an MGM Brakes spring brake equipped with an external breather-tube, the end of the breather-tube should be inserted a minimum of _____ into each elbow.
- A. 1/8-inch
 - B. 1/4-inch
 - C. 1/2-inch
 - D. 3/4-inch
 - E. None of the above
24. When properly torqued, the clamp band ears should be _____.
- A. angled away from each other
 - B. angled in toward each other
 - C. parallel to each other
 - D. touching each other
 - E. All the above
25. Placing the split or hardened-steel flat washers between the brake chamber and the bracket will _____.
- A. allow the chamber to "flex", resulting in premature failure of the N/P chamber
 - B. allow the installer to apply an additional 25 Lbs.-Ft. of torque to the nuts
 - C. provide additional support to the N/P chamber
 - D. reduce the possibility of corrosion between the bracket and N/P chamber
 - E. B & C
26. MGM Brakes recommends routine inspection of the brake chambers whenever the equipment is in the shop, or at a minimum of every 75,000 miles.
- True False**
27. To reduce the possibility of serious injury when removing an "uncaged" actuator, use a vise grip to relieve the pressure being applied to the slack adjuster.
- True False**

-
28. If the vent holes in the head of the brake become restricted with dirt or concrete, they can be reamed out using a power drill with a 3/8-inch drill bit.
True False
29. When installing an MGM Brakes spring brake equipped with an external breather-tube, the tube must be positioned in the upper quadrant, 9:00 to 3:00 o'clock, away from the road surface.
True False
30. Any hose with damage extending through the outer reinforcement ply or with a bulge or swelling when air pressure is applied will cause the vehicle to be placed "Out-of-Service" by an inspecting officer.
True False

Section 4

31. The release bolt should be inserted into the spring brake until it bottoms out, _____.
A. then install the nut and washer
B. then rotate the bolt 1/4 turn counter-clockwise
C. then rotate the bolt 1/2 turn clockwise
D. then rotate the bolt 1/4 turn clockwise
E. None of the above
32. To verify that an MGM Brakes TR2430T Model spring brake has been completely caged to zero (0) stroke, the release bolt thread should extend _____ above the nut.
A. 2.75-inches
B. 3.00-inches
C. 3.25-inches
D. 3.50-inches
E. 4.00-inches

-
33. To manually release (cage) the power spring on an MGM Brakes Model MG-T piston-type spring brake, the release bolt should _____.
- A. extend 4.00-inches above the head of the brake
 - B. be inserted into the brake and tightened to 40-45 Lbs.-Ft. of torque
 - C. be completely removed using a 3/4-inch deep well socket wrench
 - D. turned clockwise until it extends 3.25-inches above the pal nut
 - E. None of the above
34. Unlike double diaphragm spring brakes, the unscrewing or removal of the release bolt from an MGM Brakes piston type spring brake _____.
- A. does not actually "cage" the power spring
 - B. only removes the power spring force from the slack adjuster
 - C. requires a metric socket wrench
 - D. All the above
 - E. A & B
35. To make the manual release procedure easier, you can _____.
- A. apply lithium grease to the release bolt threads
 - B. use an air impact wrench
 - C. apply 90-100 psi air pressure to the air inlet port marked "Spring Brake"
 - D. remove the air lines to reduce the pressure inside the chamber
 - E. None of the above
36. Exceeding 50 Lbs.-Ft. of torque on the release-bolt nut at anytime may damage the release bolt or other internal components.
True False
37. The "removable release bolt" is essential to the release procedure and should be stored in the pocket of the brake, or in the glove box or toolbox of the vehicle.
True False
38. To accelerate the release procedure, use an impact wrench to turn the release bolt nut clockwise until the release bolt thread extends above the nut.
True False

-
39. MGM Brakes spring brakes equipped with an integral release bolt can be fully caged by turning the release bolt clockwise until the power spring is fully caged.
True False
40. The release bolt of the MGM Brakes Model LTR-L3 will extend 4.00 inches from the head of the brake when the unit is fully caged.
True False

Sections 5 & 6

41. To prevent sudden separation of the single/piggyback from the service chamber when the clamp band is removed, _____.
- A. extend the service push-rod slightly and clamp it in place with vise grip pliers
 - B. remove the pin connecting the yoke to the slack adjuster
 - C. remove the air lines to assure total release of air from within the chamber
 - D. make sure the release bolt thread extends above the nut 3.25-inches
 - E. None of the above
42. To help “seat” the clamp band, firmly tap around circumference with a plastic or rubber mallet while _____.
- A. applying pressure to the clamp band ears with vise-grip pliers
 - B. using your free hand to gently rock the piggyback from side to side
 - C. alternately tightening the nuts to 35-40 Lbs.-Ft. of torque
 - D. turning the release bolt nut in a counter-clockwise direction
 - E. None of the above
43. To detect air leaks around the clamp band and air fittings, _____.
- A. hold the brake under water to see if bubbles appear
 - B. apply soapy water or leak detection solution
 - C. apply soapy water or a light mineral oil
 - D. listen for air escaping from the clamp band and fitting areas
 - E. None of the above

-
44. When reinstalling the external breather-tube, be sure to insert the end of the tube _____ into the rubber elbow extending from the non-pressure housing.
- A. 1/4-inch
 - B. 1/2-inch
 - C. 3/4-inch
 - D. 1-inch
 - E. as far as possible
45. Before installing a new diaphragm you should _____ for damage or wear.
- A. visually inspect the return spring
 - B. visually inspect the piston plate
 - C. visually inspect the non-pressure chamber
 - D. visually inspect the flange case
 - E. All the above
46. When installing new clamp band bolts and nuts, it is best to completely tighten one of the nuts before tightening the other.
- True False**
47. When reinstalling the air supply lines, apply a non-hardening sealing compound to the fittings and tighten them to 25-30 Lbs.-Ft. of torque into the chamber air inlet ports.
- True False**
48. If leaks are detected around the circumference of the clamp band, tighten the clamp band bolts until the leaks cease.
- True False**
49. When storing the release bolt in the storage pocket on the brake, tighten the release bolt nut against the flat washer to 10 Lbs.-Ft. of torque.
- True False**
50. To uncage a spring brake with an integral release-bolt, use an impact wrench and turn the bolt until it is fully engaged into the unit and the slotted nut bottoms out.
- True False**

Sections 7 & 8

51. Before you begin to remove the combination/tandem brake from the vehicle, _____.
- A. manually release the brake
 - B. determine the manufacturer of the brake
 - C. visually inspect the brake for any damage
 - D. None of the above
 - E. All the above
52. The “X” dimension is measured from _____.
- A. the bottom of the actuator to the end of the piston rod
 - B. the bottom of the actuator to the center of the yoke pin
 - C. the bottom of the actuator to the end of the yoke
 - D. the end of the rod to the end of the threads
 - E. None of the above
53. Before marking the push-rod to be cut on the new unit, _____.
- A. remove the release bolt and place it in the storage pocket
 - B. remove the “jam nut” from the push-rod
 - C. make sure the push-rod is fully retracted to the zero (0) stroke position
 - D. insert the dust cap into the release bolt hole and snap tightly into place
 - E. All the above
54. Failure to fully cage (release) the spring brake to zero (0) stroke prior to taking the “X” and “Y” dimensions will result in _____.
- A. improper alignment of the slack adjuster
 - B. the push-rod on the new unit being cut too short
 - C. the push-rod on the new unit being cut too long
 - D. improper installation of the yoke and jam nut
 - E. None of the above
55. When servicing a vehicle equipped with MGM Brakes 3-inch “Long Stroke” spring brakes, it is essential _____.
- A. 3-inch “Long Stroke” and 2.5-inch “standard stroke” chambers not be mixed
 - B. 3-inch “Long Stroke” diaphragms be used to service 3-inch “Long Stroke” units
 - C. only the piggyback be replaced if the production unit is equipped with the MGM Brakes “Welded Yoke”
 - D. All the above
 - E. None of the above

-
56. The release bolt should be used to manually release the spring brake to assure it can be safely handled.
True False
57. If the yoke pin is rusted or frozen in the yoke, it will be necessary to remove and replace the slack adjuster.
True False
58. Before cutting the universal service push-rod, the “X” and “Y” dimensions should be estimated and marked.
True False
59. Prior to marking the push-rod to be cut on the new unit, the spring chamber and push-rod on the old unit should be fully retracted to the zero stroke position.
True False
60. If the unit being replaced is an MGM 3-inch “Long Stroke” brake equipped with the MGM Brakes “welded yoke”, replacement of the single/piggyback is recommended.
True False

Section 9

61. Prior to installing the new combination/tandem brake, you should take a few minutes to _____.
- A. apply a protective coating of grease to the bracket surface
 - B. apply a coat of epoxy paint to the bracket surface
 - C. remove any burrs or debris
 - D. ensure the bracket surface is free of cracks
 - E. C & D
62. After the brake has been installed on the bracket, make sure the push-rod is working freely and is square to the chamber bottom within _____.
- A. $\pm 5^\circ$
 - B. $\pm 4^\circ$
 - C. $\pm 3^\circ$
 - D. $\pm 2^\circ$
 - E. None of the above

-
63. A push-rod that is not square to the chamber bottom can be adjusted by _____.
- A. installing an "off-set" slack adjuster
 - B. repositioning the chamber on the mounting bracket
 - C. applying heat to the rod and bending it to fit
 - D. shimming the slack adjuster to the right or left as required
 - E. B & D
64. When installing the air lines on the chamber, _____.
- A. apply a non-hardening compound to the hose fittings
 - B. tighten the fittings into the air-inlet ports to 25-30 Lbs.-Ft. of torque
 - C. be sure each air line is mated to the correct inlet port
 - D. use soapy water or leak detection solution to check for air leaks
 - E. All the above
65. When replacing the release bolt into the storage pocket on the brake chamber, be sure to tighten the release bolt nut against the flat washer to _____.
- A. 10 Lbs.-Ft. of torque
 - B. 15 Lbs.-Ft. of torque
 - C. 20 Lbs.-Ft. of torque
 - D. 25 Lbs.-Ft. of torque
 - E. None of the above
66. When mounting the brake to the bracket, be sure to install spacers between the bracket and non-pressure housing.
True False
67. It is recommended that an impact-type wrench be used to tighten the mounting bolt nuts when installing a new chamber on the vehicle.
True False
68. When installing a brake equipped with an external breather-tube, it is important that the tube be positioned facing the road surface.
True False
69. It is important to inspect the push-rod to be sure it is working free and is square to the chamber bottom to within $\pm 6^\circ$, in any direction, at any point in the chamber stroke.
True False

70. Failure to install the end cap securely in place on a brake equipped with an external breather-tube will void the warranty.

True False

Section 10

71. To properly dispose of an old spring brake, MGM Brakes recommends _____.

- A. throwing it into a metal scrap bin
- B. caging the brake and throwing it into a metal scrap bin
- C. that the clamp band bolts be cut with an acetylene gas torch
- D. that the coils of the power spring be cut with an acetylene gas torch
- E. None of the above

72. When cutting the coils of the power spring with an acetylene gas torch, the brake should be _____.

- A. caged and placed in a bucket
- B. caged and placed in a vise on a workbench
- C. placed on the shop floor, away from combustible materials
- D. placed into a properly constructed steel container
- E. None of the above

73. The person operating the acetylene gas torch should never do so without _____.

- A. proper training
- B. proper clothing
- C. proper eye protection
- D. All the above
- E. None of the above

74. To make sure the coils of the power spring have been completely cut, you should _____.

- A. remove the chamber from the container and shake it
- B. use your finger to see if the coils of the power spring are loose
- C. remove the release bolt to see if the brake still works
- D. use a screwdriver to check that the coils are loose
- E. All the above

75. The proper disposal of old spring brake chambers is a major concern throughout the industry.

True False

-
76. Spring brake actuators should be safely disarmed to prevent serious personal injury from the sudden accidental release of the high-energy power spring.
True False
77. Wearing protective clothing and eye protection are an option when operating an acetylene gas torch.
True False
78. Cutting through the first coil of the power spring may produce a low pitched “popping” sound and cause the brake to jump inside the container.
True False

Section 11

79. During roadside inspections, the single most cited reason for a commercial vehicle to be placed “Out-of-Service” is _____.
- A. oil soaked brakes
 - B. bent or crimped air lines
 - C. audible air leaks
 - D. out-of-adjustment brakes
 - E. mismatch of chamber size
80. A fully loaded truck/trailer, traveling at 40 MPH under the best of road conditions, will require approximately _____ feet of stopping distance.
- A. 342
 - B. 298
 - C. 260
 - D. 189
 - E. None of the above
81. A Commercial Vehicle Safety Alliance (CVSA) inspector will place a truck/trailer “Out-of-Service” if the number of defective brakes is equal to or greater than _____ of the brakes on the vehicle.
- A. 10%
 - B. 20%
 - C. 30%
 - D. 40%
 - E. None of the above

-
82. A defective (out-of-adjustment) brake, 1/4-inch or more beyond the readjustment limit, will _____.
- A. count as 1/2 brake toward the 20% rule
 - B. count as 1 full brake toward the 20% rule
 - C. need to be replaced with a new unit
 - D. not have any effect on the "Out-of-Service" status of the vehicle
 - E. None of the above
83. The recommended readjustment stroke for a type 30 3-inch (76 mm) "Long Stroke" brake is _____.
- A. 1.75 inches
 - B. 2.00 inches
 - C. 2.25 inches
 - D. 2.50 inches
 - E. 3.00 inches
84. Proper brake adjustment is critical to the safe operation of commercial vehicles.
True False
85. A vehicle with 20% of its brakes defective (out-of-adjustment) will be placed "Out-of-Service".
True False
86. The number of brakes required under the 20% rule for a five (5) axle truck/trailer to be placed "Out-of-Service" is two (2).
True False
87. The last half of the chamber stroke is more efficient than the first half.
True False
88. The maximum stroke with the brakes adjusted should be as short as possible without lining to drum contact.
True False

Section 12

89. Because of the performance benefits of 3-inch “Long Stroke” chambers, CVSA has increased the readjustment limit on Type 30 chambers from 2.00 inches to _____.
- A. 2.25 inches
 - B. 2.50 inches
 - C. 2.75 inches
 - D. 3.00 inches
 - E. None of the above
90. All “Long Stroke” chambers are identified by _____.
- A. permanent markings
 - B. square inlet ports
 - C. red triangular tags
 - D. trapezoidal I.D. tags
 - E. A, B & D
91. Increase in chamber stroke caused by improper brake adjustment has little or no effect on the distance required to stop the vehicle.
True False
92. Elevated brake temperatures are a major factor in the loss of braking effectiveness.
True False
93. The performance of 2.50-inch “standard stroke” brakes that are technically in adjustment suffer little or no loss in braking performance when drum temperatures are raised to a realistic operating temperature of 600°F.
True False

Notes

Notes

Notes

MAIL-IN QUIZ FORM

Name: _____ Date: _____

Company: _____

Street: _____

City: _____ State: _____ Zip: _____



DO NOT ENLARGE ANSWER SHEET

Section 1

- 1. A B C D E
- 2. A B C D E
- 3. A B C D E
- 4. A B C D E
- 5. A B C D E
- 6. T F
- 7. T F
- 8. T F
- 9. T F
- 10. T F

Section 2

- 11. A B C D E
- 12. A B C D E
- 13. A B C D E
- 14. A B C D E
- 15. A B C D E
- 16. T F
- 17. T F
- 18. T F
- 19. T F
- 20. T F

Section 3

- 21. A B C D E
- 22. A B C D E
- 23. A B C D E
- 24. A B C D E
- 25. A B C D E
- 26. T F
- 27. T F
- 28. T F
- 29. T F
- 30. T F

Section 4

- 31. A B C D E
- 32. A B C D E
- 33. A B C D E
- 34. A B C D E
- 35. A B C D E
- 36. T F
- 37. T F
- 38. T F
- 39. T F
- 40. T F

Sections 5 & 6

- 41. A B C D E
- 42. A B C D E
- 43. A B C D E
- 44. A B C D E
- 45. A B C D E
- 46. T F
- 47. T F
- 48. T F
- 49. T F
- 50. T F

Sections 7 & 8

- 51. A B C D E
- 52. A B C D E
- 53. A B C D E
- 54. A B C D E
- 55. A B C D E
- 56. T F
- 57. T F
- 58. T F
- 59. T F
- 60. T F

Section 9

- 61. A B C D E
- 62. A B C D E
- 63. A B C D E
- 64. A B C D E
- 65. A B C D E
- 66. T F
- 67. T F
- 68. T F
- 69. T F
- 70. T F

Section 10

- 71. A B C D E
- 72. A B C D E
- 73. A B C D E
- 74. A B C D E
- 75. T F
- 76. T F
- 77. T F
- 78. T F

Section 11

- 79. A B C D E
- 80. A B C D E
- 81. A B C D E
- 82. A B C D E
- 83. A B C D E
- 84. T F
- 85. T F
- 86. T F
- 87. T F
- 88. T F

Section 12

- 89. A B C D E
- 90. A B C D E
- 91. T F
- 92. T F
- 93. T F

(fold here)

PLACE
STAMP
HERE



MGM Brakes
8530 Cliff Cameron Drive
Charlotte, NC 28269
Attn: Administration

(tape or staple here)





8530 Cliff Cameron Drive
Charlotte, NC 28269

(800) 527-1534

(704) 547-7411

(704) 547-9367 fax

e-mail: mail@mgmbrakes.com

www.MGMBrakes.com

Form No. 5043 - Revised 1/2011

(product information and specifications subject to change without notice)

© 1999 MGM Brakes All Rights Reserved Printed in U.S.A.